

1.25 Gigabit Ethernet-Single Mode Transceiver

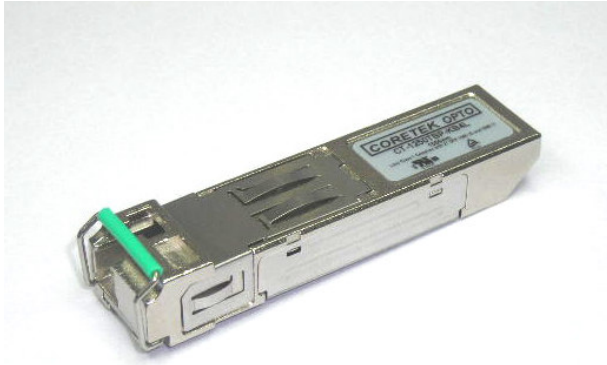

SFP BIDI, Single LC Connector, 1550nm DFB LD for Single Mode Fiber, RoHS Compliant
Digital Diagnostics Functions, Extended Operating Temperature from -40 to +85 °C

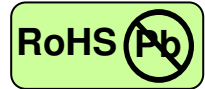

Features

- 1550nm DFB LD
- Multi Data Rate: from 125M to 1.25Gbps, NRZ
- Single +3.3V Power Supply
- RoHS Compliant and Lead-free
- AC/AC Differential Electrical Interface
- Compliant with Multi-Source Agreement (MSA) Small Form Factor Pluggable (SFP)
- Compliant with SFF-8472 Digital Diagnostic Monitoring Interface
- Single LC Connector
- Compliance with specifications for IEEE-802.3z Gigabit Ethernet at 1.25 Gbps
- Compliance with ANSI specifications for Fibre Channel applications at 1.06 Gbps
- Eye Safety
Designed to meet Laser Class 1 comply with EN60825-1

Applications

- Gigabit Ethernet Links
- Fibre Channel Links at 1.06 Gbps
- High Speed Backplane Interconnects
- Switched Backbones

Description

The CT-1250TBP-KB7L-E from Coretek Opto Corp. is the high performance and cost-effective module for serial optical data communication applications specified for single mode of multi-rate from 125M to 1.25 Gb/s. It operates with +3.3V power supply. The module is intended for single mode fiber, operates at a nominal wavelength of Tx: 1550nm / Rx: 1310nm and complies with Multi-Source Agreement (MSA) Small Form Factor Pluggable (SFP). Each module is integrated digital diagnostics functions via an I²C serial interface.

The module is a single fiber connector transceiver designed for use in Gigabit Ethernet applications and to provide IEEE-802.3z compliant link for 1.25Gb/s long reach applications. The characteristics are performed in accordance with Telcordia Specification GR-468-CORE.

EMC

Most equipment utilizing high-speed transceivers will be required to meet the following requirements:

- 1) FCC in the United States
- 2) CENELEC EN55022 (CISPR 22) in Europe

To assist the customer in managing the overall equipment EMC performance, the transceivers have been designed to satisfy FCC class B limits and provide good immunity to radio-frequency electromagnetic fields.

Eye Safety

The transceivers have been designed to meet Class 1 eye safety and comply with EN 60825-1.

1.25 Gigabit Ethernet-Single Mode Transceiver



Product Information

Model Number	Operating Voltage & SD Output	Distance	Wavelength	Output Power	Sensitivity
CT-1250TBP-KB7L-E	3.3V TTL AC/AC	60 km	1550 nm DFB / 1310 nm	-2 ~ +3 dBm	≤ -25 dBm

ABSOLUTE MAX RATINGS

PARAMETER	SYMBOL	MIN	MAX	UNIT	NOTE
Storage Temperature	T_S	-40	85	$^{\circ}\text{C}$	
Supply Voltage	V_{CC}	0	6	V	
Data Input Voltage	---	0	V_{CC}	V	
Supply Current	I_S		300	mA	

OPERATING CONDITIONS

PARAMETER	SYMBOL	MIN.	TYP.	MAX.	UNIT	NOTE
Case Operating Temperature	T_A	-40		85	$^{\circ}\text{C}$	
Supply Voltage	V_{CC}	3.1		3.5	V	
Data Input Voltage Swing	V_{ID}	300		1860	mV	

ELECTRICAL CHARACTERISTICS

PARAMETER	SYMBOL	MIN	MAX	UNIT	NOTE
Transmitter					
Transmitter Supply Current	I_{CCT}		200	mA	
Tx_Disable Input Voltage - Low	V_{IL}	0	0.8	V	
Tx_Disable Input Voltage - High	V_{IH}	2.0	V_{CC}	V	
Tx_Fault Output Voltage - Low	V_{OL}	0	0.8	V	
Tx_Fault Output Voltage - High	V_{OH}	2.0	V_{CC}	V	
Receiver					
Receiver Supply Current	I_{CCR}		100	mA	
Receiver Data Output Differential Voltage	V_{OD}	0.4	1.3	V	
Rx_LOS Output Voltage - Low	V_{OL}	0	0.8	V	
Rx_LOS Output Voltage - High	V_{OH}	2.0	V_{CC}	V	
MOD_DEF (1) , MOD_DEF (2) - Low	V_{IL}	-0.6	$V_{CC} \times 0.3$	V	
MOD_DEF (1) , MOD_DEF (2) - High	V_{IH}	$V_{CC} \times 0.7$	$V_{CC} + 0.5$	V	

TRANSMITTER ELECTRO-OPTICAL CHARACTERISTICS

PARAMETER	SYMBOL	MIN	TYP.	MAX	UNIT	NOTE
Optical Output Power	P_o	-2		3	dBm	1
Extinction Ratio	ER	9			dB	
Center Wavelength	λ_c	1530	1550	1570	nm	
Spectral Width (-20dB)	$\Delta \lambda$			1	nm	
Side Mode Suppression Ratio	SMSR	30			dB	
RIN	RIN			-120	dB/Hz	
Optical Rise time (20%-80%)	t_r			260	ps	2
Optical Fall time (20%-80%)	t_f			260	ps	2
Output Eye		Compliant with IEEE802.3z/D5.0				

1.25 Gigabit Ethernet-Single Mode Transceiver



RECEIVER ELECTRO-OPTICAL CHARACTERISTICS

PARAMETER	SYMBOL	MIN	TYP.	MAX	UNIT	NOTE
Maximum Input Optical Power	P_{max}	-3			dBm	3
	1.25Gb/s			-25		3
	1.06Gb/s			-25		3
Minimum Input Optical Power	P_{min}				dBm	4
	622Mb/s			-25		4
	155Mb/s			-25		4
	125Mb/s			-25		3
Operating Wavelength	λ	1260	1310	1360	nm	
Optical Return Loss	ORL	14			dB	
Receiver Electrical 3dB Upper Cutoff Frequency	---			1500	MHz	
LOS of Signal - Asserted	P_A	-35			dBm	
LOS of Signal - Deasserted	P_D			-24	dBm	
Loss of Signal -Hysterisis	$P_D - P_A$	0.5			dB	

Notes:

1. Measured average power coupled into 9/125 μ m single mode fiber.
2. These are 20-80% values.
3. Measured with 2^7-1 PRBS at BER< 10^{-12}
4. Measured with $2^{23}-1$ PRBS at BER< 10^{-10}

TIMING CHARACTERISTICS

PARAMETER	SYMBOL	MIN	TYP.	MAX	UNIT	NOTE
TX_DISABLE Assert Time	t_{off}			10	μ s	
TX_DISABLE Negate Time	t_{on}			1	ms	
Time to initialize, include reset of TX_FAULT	t_{init}			300	ms	
TX_FAULT from fault to assertion	t_{fault}			100	μ s	
TX_DISABLE time to start reset	t_{reset}	10			μ s	
Receiver Loss of Signal Assert Time (off to on)	t_{A,RX_LOS}			100	μ s	
Receiver Loss of Signal Assert Time (on to off)	t_{D,RX_LOS}			100	μ s	

BLOCK DIAGRAM OF TRANSCEIVER

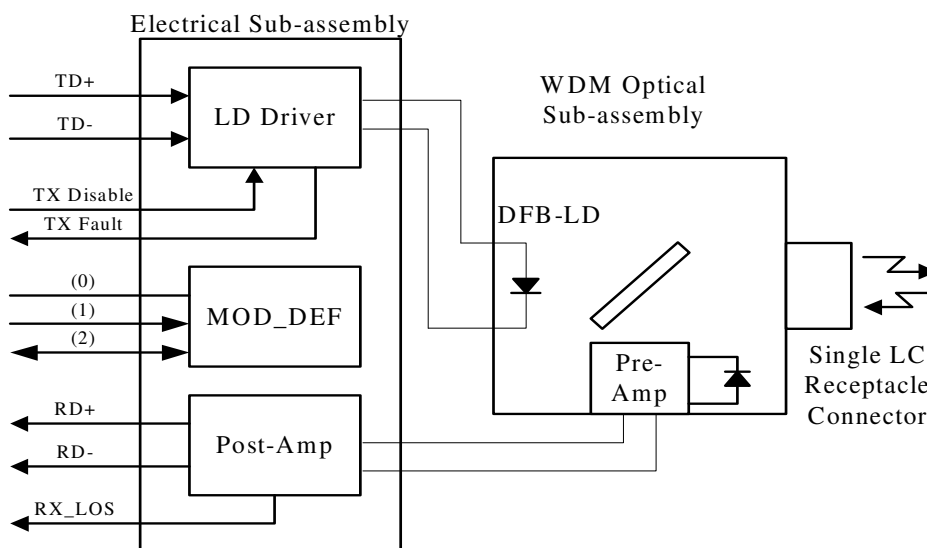

1.25 Gigabit Ethernet-Single Mode Transceiver



PIN OUT DIAGRAM OF TRANSCEIVER

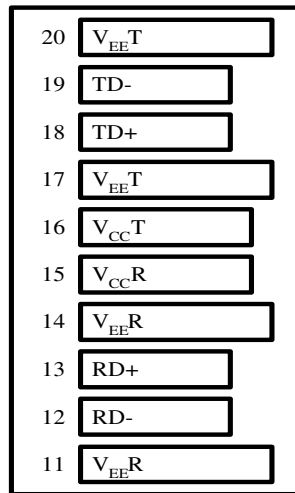

Top of Board



Bottom of Board (As Viewed through Top of Board)

PIN OUT TABLE

Pin	Symbol	Functional Description
1	VeeT	Transmitter Ground
2	TX Fault	Transmitter Fault Indication
3	TX Disable	Transmitter Disable – Module disables on high or open
4	MOD-DEF(2)	Module Definition 2 – Two wire serial ID interface
5	MOD-DEF(1)	Module Definition 1 – Two wire serial ID interface
6	MOD-DEF(0)	Module Definition 0 – Grounded in module
7	Rate Select	Not Connected
8	LOS	Loss of Signal
9	VeeR	Receiver Ground
10	VeeR	Receiver Ground
11	VeeR	Receiver Ground
12	RD-	Inverse Received Data Out
13	RD+	Received Data Out
14	VeeR	Receiver Ground
15	VccR	Receiver Power
16	VccT	Transmitter Power
17	VeeT	Transmitter Ground
18	TD+	Transmitter Data In
19	TD-	Inverse Transmitter Data In
20	VeeT	Transmitter Ground

1.25 Gigabit Ethernet-Single Mode Transceiver



RECOMMENDED CIRCUIT SCHEMATIC



MECHANICAL DIMENSIONS

Units in mm

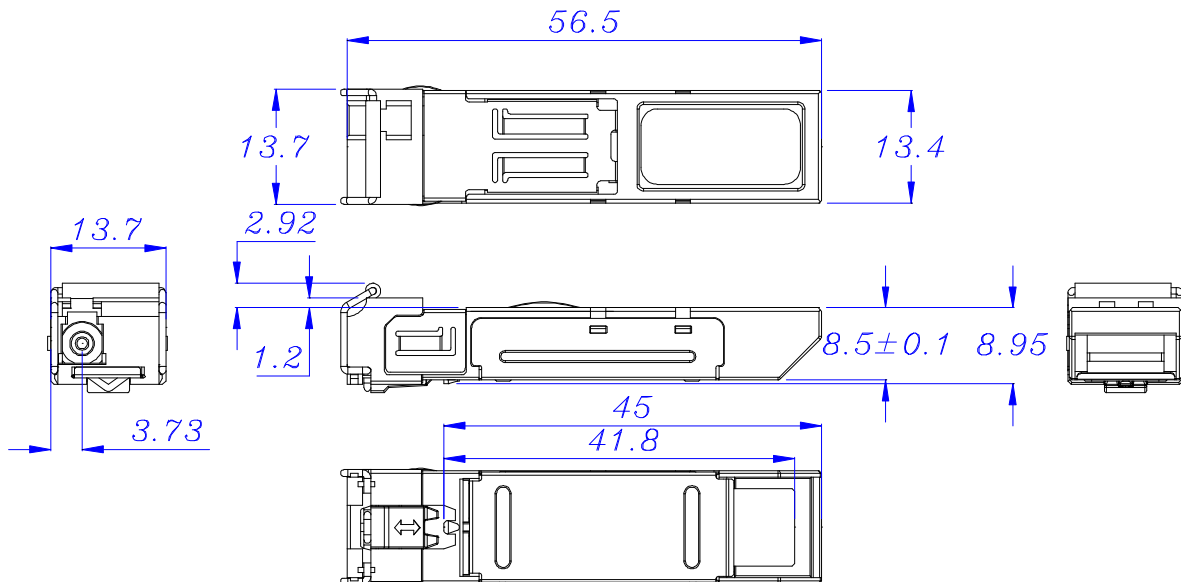

All dimensions are $\pm 0.2\text{mm}$ unless otherwise specified.

Claim:

CORETEK Opto Corp. reserves the right to make changes in the specification described hereinafter without prior notice.